

LawnMaster®

Operator's Manual

Electric High Pressure Washer LT306-1800C

Save this manual for future reference

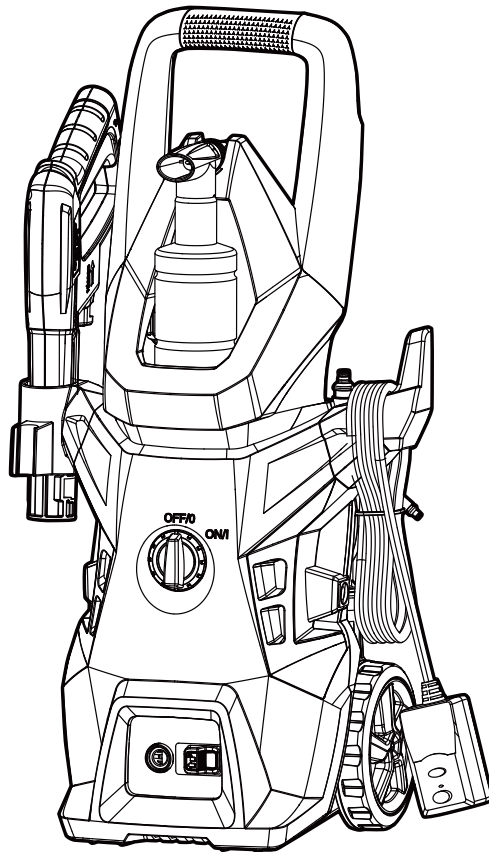

Read all safety rules and instructions carefully before operating this tool.

Distributed By: Suzhou Cleva Electric Appliance Co., Ltd.
NO.8 Ting Rong Street 215122 Suzhou - China



IPX5



TABLE OF CONTENTS

Section	Page
TABLE OF CONTENTS	2
SPECIFICATIONS	3
IMPORTANT SAFETY INSTRUCTIONS	4-7
SYMBOLS	8-9
KNOW YOUR HIGH PRESSURE WASHER	10
ASSEMBLY	11-15
OPERATION	16-20
MAINTENANCE	21-22
TROUBLESHOOTING	23-24
LAWNMASTER® WARRANTY	25
EXPLODED VIEW	26
PARTS LIST	27
NOTES	28

SPECIFICATIONS

HIGH PRESSURE WASHER LT306-1800C

Rated Voltage	120 V~
Frequency	60 Hz
Rated Current	13 A
Max Pressure	2100 PSI
Rated Pressure	1500 PSI
Rated Flow	1.4 GPM
Protection class	 / II
Weight	16.8 lbs (7.6 kg)

NOTE: For pressure washer specifications refer to the rating label on your pressure washer.

IMPORTANT SAFETY INSTRUCTIONS



WARNING

READ AND UNDERSTAND ALL INSTRUCTIONS.

When using this product basic precautions should always be followed, including the following:

- To avoid personal injury and/or damage to property and to maximize your pressure washing experience, carefully follow all of the safety tips, instructions, warnings and safeguards and become familiar with all of the controls. Be sure you know how to quickly bleed off the pressure from all parts of your pressure washer, and how to turn off the pressure washer.
- This power washer conforms to CSA and other safety and consumer standards. Do not modify or rebuild any part of your pressure washer.
- Do not use your pressure washer when you are under the influence of alcohol or drugs. Use this power tool carefully and only when you are alert.
- Watch your balance and footing while using your pressure washer. Surfaces become slippery when wet and are extra slippery when using a detergent or cleaner.
- Never operate the pressure washer in bare feet, sandals, or open-toed shoes.
- When using the pressure washer near children, make sure they are closely supervised by an adult to avoid injury. Never let a child use the power washer.
- When you press the power switch to turn off the pressure washer, water pressure may remain in the system. To discharge the pressure, point the spray gun in a safe direction and pull the trigger.
- Never spray flammable liquids.
- Never use the pressure washer in areas that contain combustible dust, liquids or vapors.
- Keep operating area clear of all persons.
- Do not overreach or stand on unstable support. Keep good footing and balance at all times.
- Follow the maintenance instructions specified in the manual.
- Do not allow the pressure hose to come in contact with sharp objects. Examine the hose regularly and replace the hose if it is damaged. Due to the high pressure the hose cannot be repaired if cut or damaged.
- Only use detergent specifically formulated for pressure washers and follow instructions on the detergent's label. Dish or laundry soap is too thick and will clog the nozzle of your detergent tank. Pressure washer detergents are available at your local hardware store.
- Protect eyes, lungs, and skin from exposure to detergent.
- Keep clear of nozzle.



WARNING

Risk of Injection or Injury– Do Not Direct Discharge Stream At Persons.

IMPORTANT SAFETY INSTRUCTIONS



IMPORTANT!

Store the power washer indoors to prevent the water in the unit from expanding under freezing conditions.

When the water freezes and expands, your power washer will be damaged and become inoperable. After disconnecting the water supply and before disconnecting the high pressure hose, turn the pressure washer on for 2-3 seconds, then turn the unit off immediately.

- Never use hot water with your pressure washer. It will overheat and damage the high pressure pump.
 - Never leave the pressure washer unattended while it is powered on.
 - Always turn the water supply on before turning the pressure washer power to on position. Running the pump dry will cause damage to the internal components.
 - Never use a water supply to your pressure washer that exceeds 150 PSI maximum.
 - Keep fingers, hands, and any part of your body clear of the stream of high pressure water. The powerful spray can cause injury to skin and body. It can break a window if you are too close when you pull the trigger on the spray gun.
 - Always wear eye protection to prevent injury to eyes when operating the pressure washer.
 - To avoid mishaps or injury, always use the trigger safety lock when not using the pressure washer even if the spraying stops for a moment.
 - The pressure washer is equipped with a Ground Fault Circuit Interrupter (GFCI) built into the power cord plug which greatly reduces the chance of electric shock while the unit is in use. If replacement of the plug or cord is needed, use only identical replacement parts.
 - Point the spray gun in a safe direction when beginning a power washing session.
 - When first using the spray gun, hold the spray gun and lance with two hands when pulling the trigger until you get used to the “kick back” from the spray gun (one hand to pull the trigger and the other to stabilize the gun assembly).
 - Never disconnect the high pressure hose from the power washer while the system is pressurized.
 - Never permanently engage the trigger mechanisms on the spray gun.
 - Never operate the pressure washer unless all components are properly and securely connected.
 - Never allow the pressure washer pump to run for more than one minute after turning off the water supply. This can cause the motor and pump to overheat and fail.
 - Never use lances or other parts that have not been supplied with your power washer.
 - Never use accessories that have not been supplied with this pressure washer. Only use included parts.
 - Never spray electrical outlets or electrical components with your pressure washer.
-



WARNING

If connection is made to a portable water system, the system should be protected against backflow.

IMPORTANT SAFETY INSTRUCTIONS

EXTENSION CORDS



WARNING

Use only extension cords that are intended for outdoor use. These extension cords are identified by "Acceptable for use with outdoor appliances; store indoors while not in use". Only use extension cords that are not rated less than the rating of the product. Do not use damaged extension cords. Examine extension cord before using and replace if damaged. Do not abuse extension cord and do not yank on any cord to disconnect. Keep cord away from heat and sharp edges. Always disconnect the extension cord from the receptacle before disconnecting the product from the extension cord.



WARNING

To reduce the risk of electrocution, keep all connections dry and off the ground. Do not touch plug with wet hands.

SPECIFIC SAFETY INSTRUCTIONS FOR HIGH PRESSURE WASHER

- Make sure your extension cord is in good condition. When using an extension cord, be sure to use one heavy enough to carry the current your product will draw. A wire gauge size (A.W.G.) of at least 14 is recommended for an extension cord 50 feet or less in length. If in doubt, use the next heavier gauge. The smaller the gauge number, the heavier the cord. An undersized cord will cause a drop in line voltage resulting in loss of power and overheating.
- Do not point the pressure washer nozzle in the direction of people or pets.
- Never place the pressure washer on any surface, except a hard, clean surface when motor is running. Gravel, sand, and other debris can be picked up by the air inlet and thrown at the operator or bystanders, causing possible serious injuries.
- Never run the unit without the proper equipment attached. Always ensure the pressure washer tubes are installed.
- When not in use, the pressure washer should be stored indoors in a dry, locked up place, out of the reach of children.
- Maintain tool with care. Follow instructions for proper maintenance.
- Do not attempt to clear clogs from tool without first unplugging it.
- Do not pull or carry by cord, use cord as a handle, or pull cord around sharp edges or corners. Keep cord away from heated surfaces.
- If the power supply cord is damaged, stop using the unit. Take the unit to a qualified service dealer for inspection and possible repair.

IMPORTANT SAFETY INSTRUCTIONS



WARNING

Injection hazard: equipment can cause serious injury if the spray penetrates the skin. Do not point the gun at anyone or any part of the body. In case of penetration seek medical aid immediately.



WARNING

This system is capable of producing 13,000 kpa. To avoid rupture and injury, do not operate this pump with components rated less than 13,000 kpa working pressure (including but not limited to spray guns, hose, and hose connections).



WARNING









Before servicing, cleaning, or removal of any part, shut off power and relieve pressure.

SAVE THESE INSTRUCTIONS

Refer to them frequently and use them to instruct others who may use this tool. If you loan someone this tool, loan them these instructions also.



SYMBOLS

Some of the following symbols may be used on this product. Please study them and learn their meaning. Proper interpretation of these symbols will allow you to operate the product better and safer.

SYMBOL	NAME	DESIGNATION/EXPLANATION
V	Volts	Voltage
A	Amperes	Current
Hz	Hertz	Frequency (cycles per second)
W	Watt	Power
min	Minutes	Time
~	Alternating Current	Type of current
≡	Direct Current	Type or a characteristic of current
	Class II Construction	Double-insulated construction
	Safety Alert Symbol	Indicates a potential personal injury hazard.
	Read The Operator's Manual	To reduce the risk of injury, user must read and understand Operator's Manual before using this product.
	Eye and Hearing Protection	Always wear eye protection with side shields marked to comply with ANSI Z87.1, along with hearing protection.
	Wet Conditions Alert	Do not expose to rain or use in damp locations
	Keep Bystanders Away	Keep all bystanders at least 50 ft. away.
	Gloves	Wear non-slip, heavy-duty protective gloves when handling this equipment.
	Safety Footwear	Wear non-slip safety footwear when using this equipment.
	Electric Shock	Failure to use in dry conditions and to observe safe practices can result in electric shock.

SYMBOLS

The following signal words and meanings are intended to explain the levels of risk associated with this product.

SYMBOL	SIGNAL	MEANING
	DANGER	Indicates an imminently hazardous situation, which, if not avoided, will result in death or serious injury.
	WARNING	Indicates a potentially hazardous situation, which, if not avoided, could result in death or serious injury.
	CAUTION	Indicates a potentially hazardous situation, which, if not avoided, may result in minor or moderate injury.
	NOTICE	(Without Safety Alert Symbol) Indicates a situation that may result in property damage.

SERVICE

Service requires extreme care and knowledge and should be performed only by a qualified service technician. When servicing, use only identical replacement parts.

For troubleshooting or replacement, please call Customer Service for assistance (Toll free number 866-384-8432).

WARNING

To avoid serious personal injury, do not attempt to use this product until you read thoroughly and understand completely the Operator's Manual.

If you don't understand the warnings and instructions in the Operator's Manual, do not use this product. Call Customer Service for assistance (Toll free number 866-384-8432).

KNOW YOUR HIGH PRESSURE WASHER

The safe use of this product requires understanding of the information on the product and in this operator's manual as well as knowledge of the project you are attempting.

Before use of this product, familiarize yourself with all operating features and safety rules.

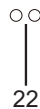
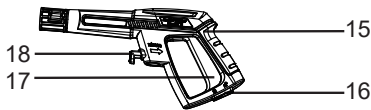
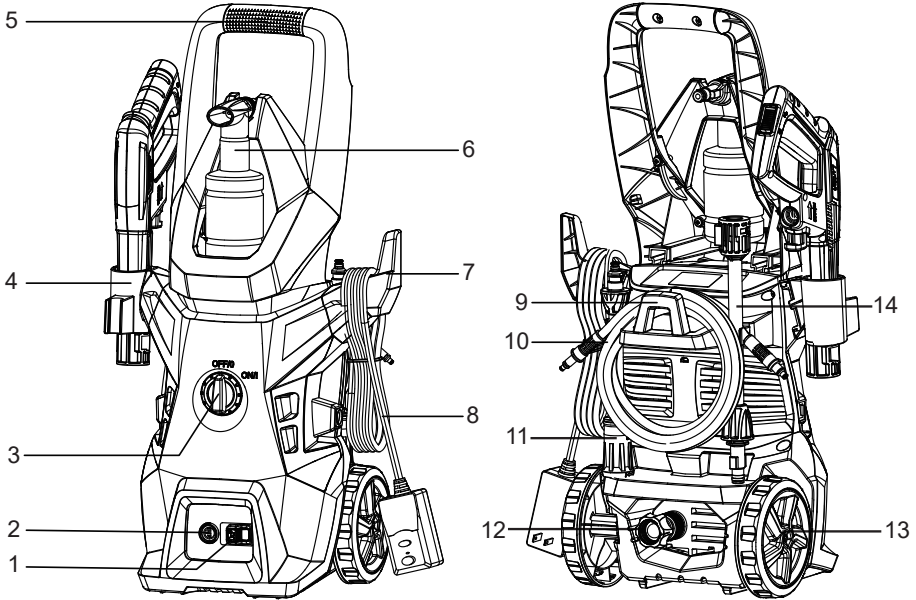

- | | | |
|--|--|--|
| 1. Release Button (under the Front of the Machine) | 10. High Pressure Hose | 19. Tip Cleaner (Attached at the Back of the Manual) |
| 2. Water Outlet | 11. Spray Wand | 20. Water Inlet Connector |
| 3. On/Off switch | 12. Water Inlet | 21. Screw (X4) |
| 4. Spray Gun Hook | 13. Wheel | 22. Spare O-ring (X2) |
| 5. Transport Handle | 14. Extension Wand | |
| 6. Detergent Bottle | 15. Spray Gun Handle | |
| 7. Cable Hook | 16. Safety Lock | |
| 8. Power Cable & GFCI | 17. Trigger | |
| 9. Accessories Holder | 18. Release Button (on the Spray Gun Handle) | |

ASSEMBLY

UNPACKING

This product requires assembly.

- Carefully remove the product and any accessories from the box. Make sure that all items listed in the packing list are included.
- Inspect the product carefully to make sure no breakage or damage occurred during shipping.
- Do not discard the packing material until you have carefully inspected and satisfactorily operated the product.
- If any parts are damaged or missing, please call Customer Service (Toll free number 866-384-8432).

YOU WILL NEED (ITEMS NOT SUPPLIED)

- Suitable Personal Protective Equipment
- Phillips screwdriver

PACKING LIST

- (1) Pressure Washer Unit
- (1) Spray Gun Handle
- (1) Extension Wand
- (1) Spray Wand
- (1) High Pressure Hose
- (1) Accessories Holder
- (1) Transport Handle
- (1) Cable Hook
- (1) Spray Gun Hook
- (1) Detergent Bottle
- (2) Wheels
- (1) Tip Cleaner (Attached at the Back of the Manual)
- (1) Water Inlet Connector
- (4) Screws
- (2) Spare O-rings
- (1) Operator's Manual



WARNING

Do not use this product if any parts on the Packing List are already assembled to your product when you unpack it. Parts on this list are not assembled to the product by the manufacturer and require customer installation. Use of a product that may have been improperly assembled could result in serious personal injury.

ASSEMBLY



WARNING

If any parts are damaged or missing, do not operate this product until the parts are replaced. Failure to pay attention to this warning could result in serious personal injury.



WARNING

Do not attempt to modify this product or create accessories not recommended for use with this product. Any such alteration or modification is misuse and could result in a hazardous condition leading to possible serious personal injury.



WARNING

Do not connect to power supply until assembly is complete. Failure to comply could result in accidental starting and possible serious personal injury.

ASSEMBLING THE HIGH PRESSURE WASHER

- The spray gun hook and cord hook can be attached by sliding them onto the slots found on the body of the pressure washer (Fig. 1).
- Attach the accessories holder tight to the main body with two screws provided using a Phillips screwdriver. Do not over-tighten the screws (Fig. 2).

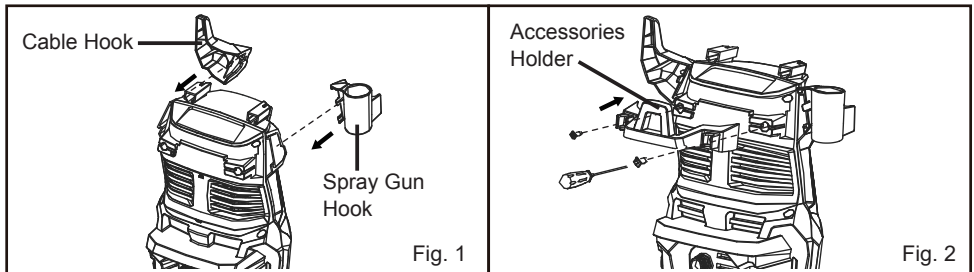

- Install the two wheels to the main body (Fig. 3).
- Attach the transport handle to the body of the pressure washer with two screws provided using a Phillips screwdriver. Do not over-tighten the screws (Fig. 4).

ASSEMBLY

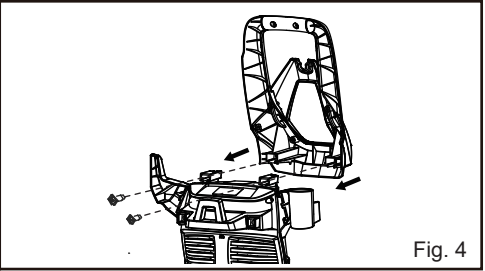
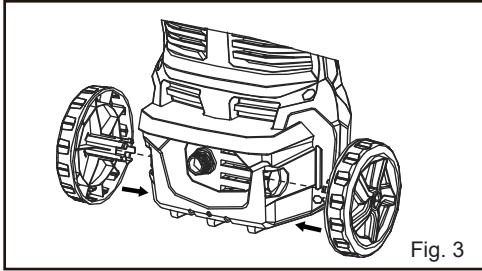

- Align and insert the extension wand into the spray gun handle. Push and turn the extension wand clockwise until the two parts are completely joined. When the two parts are joined properly, you cannot separate them by pulling straight out on the extension wand (Fig. 5).
- Align and insert the spray wand into the extension wand, and push it onto the extension wand until a click is heard. To remove the spray wand, press the spray wand release button and pull it out (Fig. 6).

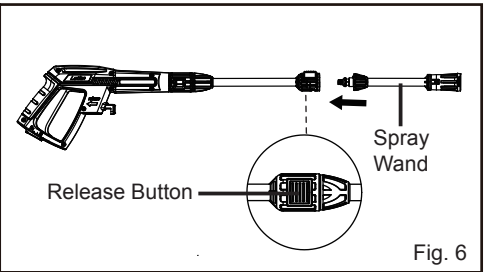
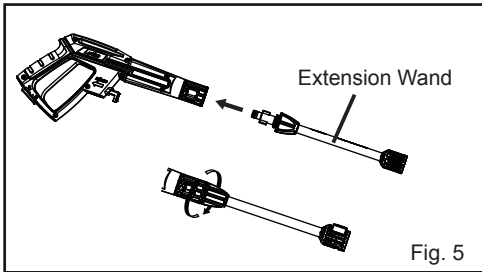

- Attach the high pressure hose to the spray gun. Insert and quick-connect it tight to avoid leakage. When the pieces are joined properly, you cannot separate the two components by pulling straight out from the gun. To release the high pressure hose, push the release button on the spray gun handle, then pull out high pressure hose (Fig. 7).

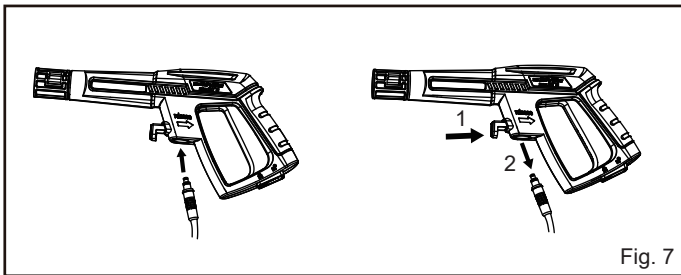

ASSEMBLY

- Attach the high pressure hose to the water outlet under the front of the pressure washer. Insert and quick-connect it tight to avoid leakage. When the pieces are joined properly, you cannot separate the two components by pulling straight out from the water outlet. Push the release button according to the direction of arrow, then you can pull out the high pressure hose (Fig. 8).

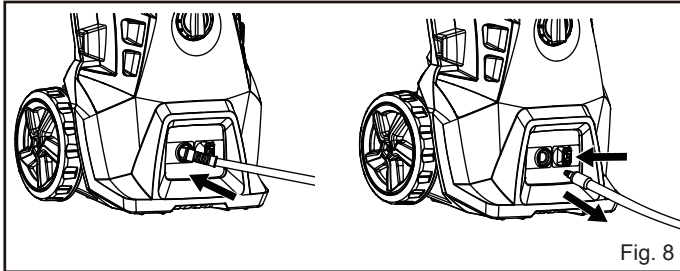

- Attach the water inlet connector to the water inlet at the back of the pressure washer (Fig. 9). Before attaching the connector, remove the plastic cap, which is inserted onto the male fitting on the pressure washer before shipping. This plastic cap can be discarded once removed.
- Position the pressure washer close to the water supply. The pressure washer must be used standing on a secure, stable level ground.
- Prepare the work area for cleaning, ensuring all doors and windows are closed tight.
- Inspect the general condition of the pressure washer. Check for loose screws, misalignment or binding of moving parts, damaged electrical wiring, damaged high pressure hose, damaged accessories, and any other condition that may affect its safe operation.
- Connect the water supply hose (not supplied) to the water inlet connector (Fig. 9). The supply hose must have an internal diameter of less than 1/2" (12.7 mm) and must be reinforced. The length can not be greater than 8 m.
- Connect the water supply hose to water tap, or put the water supply hose with filter into the water tanks or natural sources (Fig. 10).

NOTE: Maximum suction head is less than 1.6 feet (0.5 m).

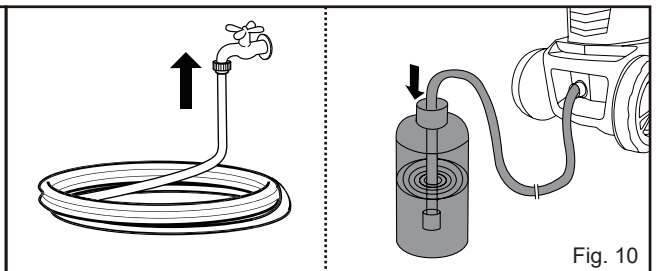
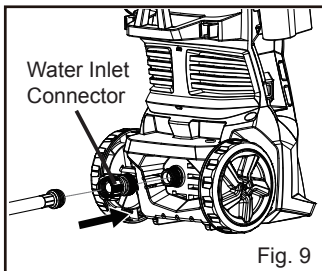

ASSEMBLY



WARNING

The intake water temperature must not exceed 122°F (50°C). The water supply must not exceed 174 PSI.



CAUTION

The pressure washer must only be used with clean water, and is not suitable for connection to the potable water main, use of unfiltered water or corrosive chemicals will damage the pressure washer.

OPERATION



WARNING

This unit is intended to be used with cold water only. Do not use hot water in this pressure washer.



WARNING

High pressure hose must not loop.



WARNING

Danger! During operation the unit must be positioned on a firm, stable surface.



WARNING

ALWAYS turn off the unit's motor BEFORE turning off the unit's water supply. Serious damage could occur to the motor if the unit is running without water.

FOR MUNICIPAL WATER SUPPLY

- Unwind the power cord completely and plug the GFCI into a 120 volt outlet. Press the "TEST" button on the GFCI, power will be cut and indicator will fade. Do not use if this test fails. We recommend pressing the test button each time the pressure washer is used to ensure the protector works. Press the RESET button, the indicator light will come on when the power is on (Fig. 11).
- Connect the pressure washer to the water supply ensuring that the On/Off switch on the pressure washer is in the OFF position. If abnormal noise or vibration occurs, have the problem corrected before further use. Do not use damaged equipment.
- Turn on the water supply.
- Before turning the pressure washer on, first press the safety lock on the bottom of the spray gun handle, and then press the trigger until there is a constant flow of water from the pressure washer (Fig. 12). Release the trigger.

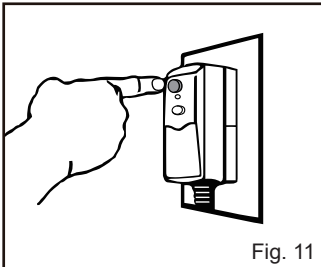

Fig. 11

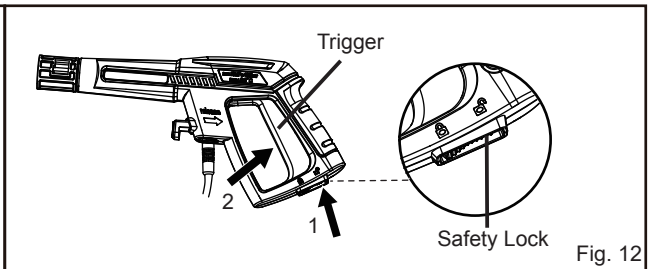

Fig. 12

OPERATION

NOTE: Check if water leaks from joints. If water leaks, please reconnect the water hose, the spray gun or the attachment to make sure each accessory are connected correctly.

- Turn the On/Off switch to the ON position (Fig. 13). Point the spray gun downwards. Fully press the trigger and begin spraying.
- The spray wand nozzle will allow you to use any variety of spray patterns from a full fan spray (A) to a direct stream spray (B) (Fig. 14).

When using the pressure washer to clean wood decks, siding, vehicles etc., always start using the fan spray and begin spraying from a minimum 36" away to avoid damaging the surface of the material you are cleaning. Always begin by spraying in a testing area free and clear of people and objects.

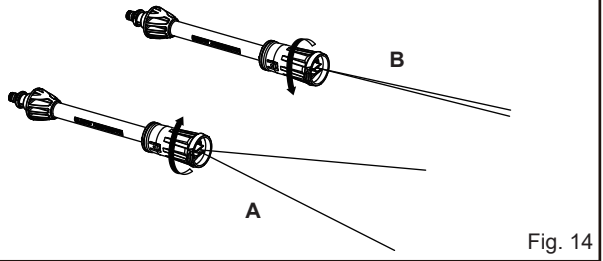
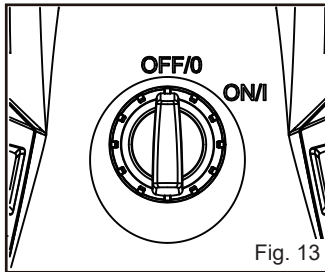

WARNING

High pressure jets can be dangerous if subject to misuse. The jet must not be directed at persons, live electrical equipment or the appliance itself.

Do not direct the jet against yourself or others in order to clean clothes or foot-wear.

-
- The pressure washer is designed to switch off the motor when the trigger is released. To stop spraying, simply release the trigger.

NOTE: When not using the pressure cleaner, press the safety lock to lock position to keep from accidentally engaging the high pressure spray.

- Turn the on/off switch to the OFF position and unplug it from the electrical outlet once you are done using it.
- Turn off the water supply and squeeze the trigger 2-3 times to depressurize the unit.
- Disconnect the high pressure hose.



CAUTION

Never disconnect the high pressure hose from the machine while the system is still pressurized.

OPERATION

FOR OPEN TANKS/CONTAINERS AND NATURAL WATER SOURCES

- Use the reinforced supply hose with an inlet strainer and non-return valve.
- Submerge the water supply hose in water to displace the air. Connect the supply hose to the pressure washer and ensure that the inlet strainer remains submerged in the water source (Fig. 15). The height from the water level and the pressure washer should be less than 1.6 feet (0.5 m).
- Run the pressure washer until a steady flow of water appears from the high pressure hose (Fig. 16). Stop if this does not happen within 25 seconds and check all the connections. Switch off and connect the pressure hose to the spray gun, extension wand and spray wand to operate.
- It is important to ensure that all hose and coupling connections are of good quality, air tight and that all washers are in good condition and correctly seated in place. Failure to do so may affect performance.

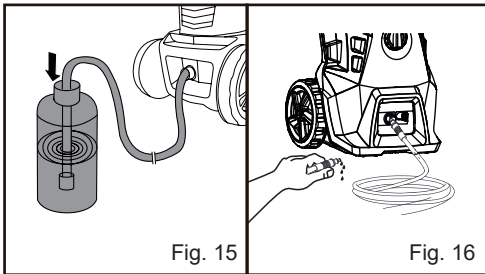

CHANGING ACCESSORIES

- Release the trigger. Turn the on/off switch to the OFF position.
- Disassemble the spray wand from the extension wand. Press the spray wand release button and pull it out.
- Disassemble the extension wand. Push back the extension wand towards the gun handle and turn it counter-clockwise to remove (Fig. 17).
- Align and insert the desired accessory into the spray gun handle. Push and turn the accessory clockwise until the two parts are completely joined (Fig. 18).

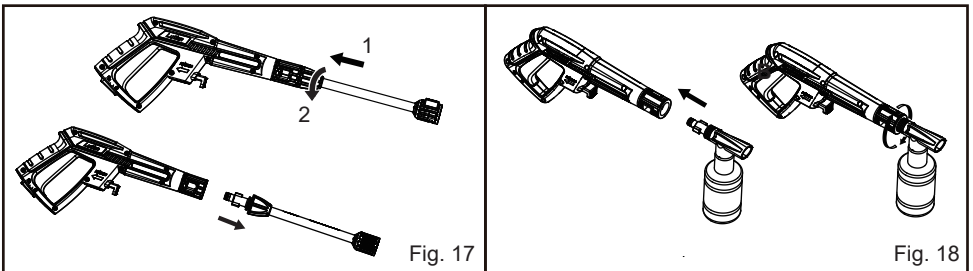

OPERATION

USING DETERGENTS



WARNING

Only use detergent specifically formulated for pressure washers and follow instructions on the detergent's label. Dish or laundry soap is too thick and will clog the nozzle of your detergent tank. Pressure washer detergents are available at your local hardware store.

The use of detergents can dramatically reduce cleaning time and assist in the removal of difficult stains. Some detergents have been customized for pressure washer use on specific cleaning tasks. These detergents are approximately as thick as water. The use of thicker detergents, such as dish soap, will clog the chemical injection system and prevent the application of the detergent.

The cleaning power of detergents comes from applying them to a surface and giving the chemicals time to break down the dirt and grime. Detergents work best when applied at low pressure.

- Remove the detergent dispenser from the detergent bottle, and add detergent to the bottle (Fig. 19).
- Assemble the bottle with detergent dispenser.
- Assemble the detergent bottle to the spray gun handle following instructions of Step 4 in the CHANGING ACCESSORIES section.

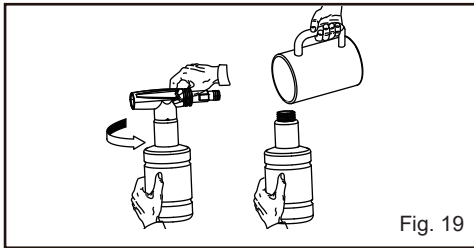

WARNING

Never use products with bleach or chlorine or any other corrosive materials, including liquids containing solvents (i.e. gas, oils etc), tri-sodium phosphate products, ammonia, or acid-based cleaners. These chemicals will harm the unit and cause damage to the surface being cleaned. Always read the label.

AFTER USING YOUR PRESSURE WASHER

- When storing, drain water out of pump by running motor for a few seconds. Pull trigger to release all water. Freezing temperatures will damage the pressure washer if it contains water.
 - Turn off the On/Off switch. Remove the plug from the electrical socket.
 - Turn off the water supply tap.
-

OPERATION

- Before disconnecting high pressure hose connection, discharge residual pressure by pressing the trigger until no more water comes out of the spray wand nozzle.
- Engage the gun safety lock.
- Remove the high pressure hose from the spray gun and pressure washer. Remove the water supply hose from the pressure washer and water source.
- Wipe away any remaining water on all parts and fittings. Store the pressure washer indoors, in a dry environment that does not allow for freezing temperatures.
- Flush the pressure washer with automotive antifreeze prior to long-term storage.

WORKING HINTS FOR YOUR PRESSURE WASHER

- Before connecting the water supply hose to the pressure washer, run water through the water supply hose (not provided) to remove any debris (Fig. 20).

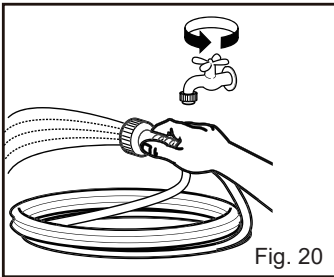

- This pressure washer will self prime and can draw water from water tanks and natural water sources. It is important that the water is clean and the inlet filter is clear and fitted to the water supply hose. The height from water level to pressure washer is less than 1.6 feet (0.5 m).
- Clean an inconspicuous test area first. Always begin with the fan spray at a distance of about 3.28-5.0 feet (1-1.5 m) from the surface being cleaned to avoid damaging it. After cleaning this area, switch off the pressure washer and inspect the area carefully for any damage or discoloration.
- If several different surfaces are to be cleaned, be careful not to damage any of the less solid surfaces while trying to clean the harder ones. This is especially a concern when cleaning tile and grout, bricks and mortar, or stones and mortar.
- If wood is being cleaned, be careful to avoid damage. Wood will usually require resurfacing (sanding) and recoat with a surface protectant (wood, stain, varnish) after it has dried. Try to avoid leaving water on a wooden surface; doing so can harm the surface.
- If using detergent, allow the detergent to rest on the surface for a few minutes, but do not let the detergent dry.



CAUTION

The machine is intended for cleaning areas and objects outside the house, tools, vehicles and boats. Intended use is related to operation within 32°F (0°C) and 104°F (40°C) ambient temperature. Only use water without any impurities.

MAINTENANCE



WARNING

Always switch the product off, disconnect it from the power supply and disconnect from water supply before performing maintenance.



WARNING

Do not use any attachments or accessories that are not recommended by the manufacturer of this product. Using attachments or accessories not recommended can result in serious personal injury.



WARNING

Always wear protective, heavy gloves and use protective safety equipment when performing maintenance. Ensure the power plug is disconnected from the power supply. Failure to pay attention to this warning could result in serious personal injury.

- This pressure washer is supplied with a closed lubrication system, so no addition of oil is needed.
- Check all hoses and accessories for damage prior to use.
- Check the inlet filter periodically for deposits. Clean this filter regularly for maximum performance.
- Check for obvious defects regularly such as loose fixings, and worn or damaged components.
- Turn the switch off and operate the trigger to drain the water from the high pressure hose. Use only a clean cloth and mild detergent to clean the body of the pressure washer. Do not use solvents. Do not immerse any part of the tool in liquid. Dry off any remaining water on all parts and fittings.
- Clean the nozzle with the tip cleaner provided. Remove the spray wand from the gun and then remove any dirt from the nozzle hole and rinse (Fig. 21).
- To ensure an easy connection and o-rings do not dry up, the couplings should be greased regularly (Fig. 22).
- Replace the o-ring if there is obvious damage to the o-ring, water leakage on the high pressure hose connections, or spray gun connections. Confirm that the o-ring has been installed correctly (Fig. 23).

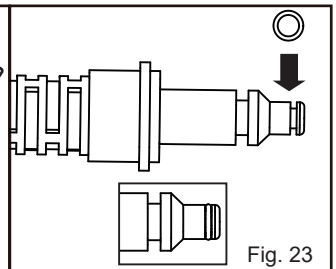
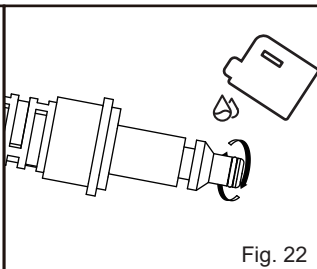
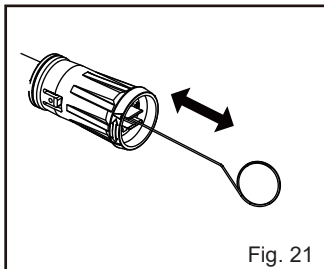

MAINTENANCE

- Check all cables periodically. They must be in good condition and not cracked. If the cable is damaged, contact customer service or take it to a qualified service technician for repair to avoid a hazard.
- The detergent bottle can be put on the handle area for easy storage (Fig. 24).

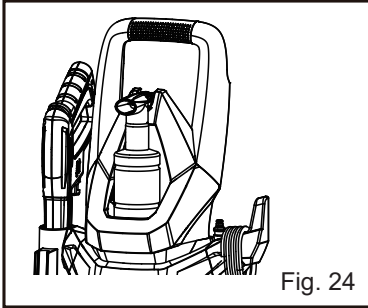

Fig. 24

TROUBLESHOOTING

Suspected malfunctions are often due to causes that the user can fix themselves.

Therefore, check the product using this section. In most cases the problem can be solved quickly.

WARNING

Only perform the steps described within these instructions!

All further inspection, maintenance and repair work must be performed by an authorized service center or a similarly qualified specialist if you cannot solve the problem yourself!

Gloves and appropriate protective clothing must be worn when performing these instructions. Always turn off the machine, disconnect it from the power supply, and disconnect from water supply before making any adjustment.

PROBLEM	POSSIBLE CAUSE	SOLUTION
The pressure washer fails to start.	The plug is not connected.	Connect the plug.
	No power supply.	Check the socket, fuse, cable, wire and plug and have any repairs carried out by a qualified person.
	Extension cable is damaged.	Replace with a new extension cord.
	The motor protector has activated.	Allow to cool for 10 minutes.
The motor stops.	Wrong power supply voltage.	Check that power supply voltage corresponds to specifications on the model tag.
	The motor protector has activated.	Allow to cool for 10 minutes.
Fuses blow.	Fuses incorrectly rated.	Change to a power supply higher than the pressure washer amp consumption.
Motor "sounds" but fails to start.	Insufficient power supply.	Check that the voltage of the power supply line is the same as that on the plate.
	Voltage loss due to use of extension cable.	Check specifications of extension cable.
	Appliance not used for a long period of time.	Contact Customer Service at (866) 384-8432.

TROUBLESHOOTING

PROBLEM	POSSIBLE CAUSE	SOLUTION
Pressure pulsating.	Air in the inlet water supply hose/pump.	Allow pressure washer to run with open spray handle and nozzle at low pressure until regular working pressure is obtained.
	Inadequate water supply.	Check that the water supply corresponds to specifications. The diameter for the water supply hose is less than 1/2 inch or 12.7 mm.
	Water filter blocked.	Clean water filter.
	Water supply hoses squeezed.	Straighten out kinked water supply hoses.
Pressure too low, but steady	Nozzle worn.	Change the nozzle.
	Start/stop valve worn.	Activate trigger five times in quick succession.
Motor starts up but no water comes out or no working pressure.	No water supply.	Connect water supply.
	Water filter clogged up.	Clean the water filter.
	Nozzle clogged up	Clean nozzle.
	Suction distance is more than 1.6 ft (0.5 m).	Position pressure washer to the lower place.
The pressure washer starts irregularly by itself.	Pump/power gun leaky.	Contact Customer Service at (866) 384-8432.
Water leaks from machine.	Leaking pump.	A slight water leak is permissible, in case of excessive leak, contact Customer Service.

LAWNMASTER® WARRANTY

We take pride in producing a high quality, durable product. This Lawnmaster® product carries a limited one (1) year warranty against defects in workmanship and materials from date of purchase under normal household use. If product is to be used for commercial, industrial or rental use, a 30 day limited warranty will apply. Warranty does not apply to defects due to direct or indirect abuse, negligence, misuse, accidents, repairs or alterations and lack of maintenance.

Please keep your receipt/packing list as proof of purchase. This warranty gives you specific legal rights, and you may have other rights, which vary from state to state.

For product service call Customer Service at 1-866-384-8432.

Items not covered by warranty :

1. Any part that has become inoperative due to misuse, commercial use, abuse, neglect, accident, improper maintenance, or alteration; or
2. The unit, if it has not been operated and/or maintained in accordance with the owner's manual; or
3. Normal wear, except as noted below;
4. Routine maintenance items such as lubricants, wearing parts like water inlet connector, high pressure hose, tip cleaner, spray wand and gun are not covered under this Warranty;
5. Normal deterioration of the exterior finish due to use or exposure.

Transportation Charges : Transportation charges for the movement of any power equipment unit or attachment are the responsibility of the purchaser. It is the purchaser's responsibility to pay transportation charges for any part submitted for replacement under this warranty unless such return is requested in writing by Lawnmaster®.

SAVE YOUR RECEIPTS. THIS WARRANTY IS VOID WITHOUT THEM.

EXPLODED VIEW

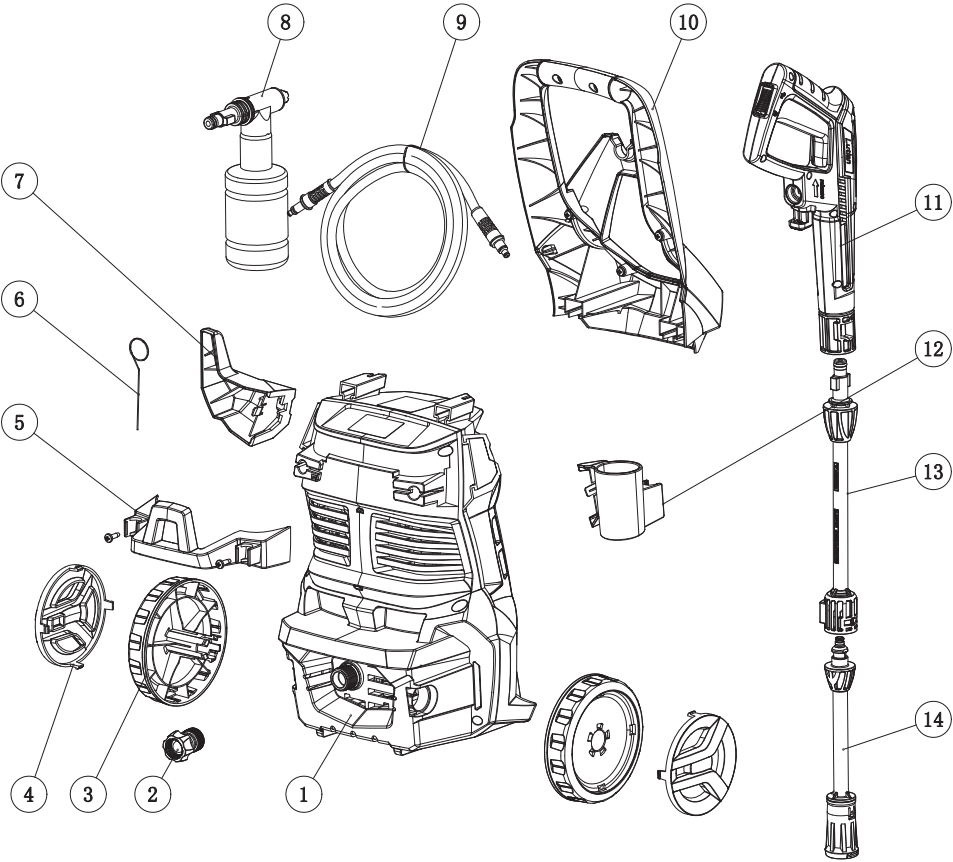

PARTS LIST

Key Number	Part Number	Description	Quantity
1		Pressure Washer Unit	1
2	691002102	Water Inlet Connector	1
3		Wheel	2
4		Wheel Cover	2
5		Accessories Hook	1
6	691002106	Tip Cleaner	1
7		Cable Hook	1
8		Detergent Bottle	1
9	691002109	High Pressure Hose	1
10		Handle	1
11	691002111	Spray Gun	1
12		Spray Gun Hook	1
13	691002113	Extension Wand	1
14	691002114	Spray Wand	1

Replacement parts highlighted in grey are available for after sales purchase. Replacement of repair or internal parts should only be done by a qualified service professional. Please contact your authorized service dealer or Customer Service at 866-384-8432.

